

RT SERIES

ROUGH TERRAINS SCISSOR LIFTS



Performance

Platform Height—Elevated		
3394RT	33 ft	10.06 m
4394RT	43 ft	13.11 m
530LRT	53 ft	16.2 m
Platform Capacity		
3394RT	2,250 lb	1,020 kg
4394RT/530LRT	1,500 lb	680 kg
Capacity on Platform Extension	500 lb	227 kg
Capacity with Dual Extensions		
3394RT	2,000 lb	907 kg
4394RT	1,250 lb	567 kg
530LRT	1,500 lb	680 kg
Lift/Lower Time		
3394RT	30/30 seconds	
4394RT	40/43 seconds	
530LRT	59/55 seconds	
Maximum Drive Height		
3394RT/4394RT	Full Height	
530LRT	30 ft	9.14 m
Weight w/One Extension*		
3394RT	11,910 lb	5,402 kg
4394RT	15,300 lb	6,940 kg
530LRT	17,000 lb	7,711 kg
Ground Bearing Pressure		
3394RT	73 psi	5.1 kg/cm ²
4394RT	83 psi	5.8 kg/cm ²
530LRT	90 psi	6.3 kg/cm ²
Drive Speed		
3394RT/4394RT	4.0 mph	6.4 km/h
530LRT	3.5 mph	5.6 km/h
Gradeability		
3394RT/4394RT	45%	
530LRT	40%	
Turning Radius (Inside)		
3394RT/4394RT	8 ft 10.5 in.	2.71 m
530LRT	8 ft 11 in.	2.72 m
Turning Radius (Outside)		
3394RT/4394RT	19 ft 5.5 in.	5.93 m
530LRT	19 ft 5 in.	5.92 m

* Certain options or country standards will increase weight.

Standard Specifications

Engine

Make and Model		
Dual Fuel(Water-Cooled)		
3394RT/4394RT	GM Vortec 3000 MPFI 82 hp 61 kW	
530LRT	Kubota WG972 29 hp 21.6 kW	
Diesel Fuel (Air-Cooled)		
3394RT/4394RT	Deutz D2011L03 48.8 hp 36.4 kW	
530LRT	Kubota D1305 24.8 hp 18.5 kW	
Fuel Tank Capacity		
3394RT/4394RT	30 gal.	113.56 L
530LRT	22 gal.	83.3 L



Tires

Standard	
3394RT/4394RT	33 x 15.5 Superwide
530LRT	12 x 16.5 Foam-Filled

Brakes

- 4 Wheel Spring Applied

Hydraulic Reservoir

- Capacity 32 gal. 121.42 L

Standard Features

- 4-Wheel Drive
- Automatic Transmission
- Three-Speed Drive Select
- Proportional Drive/Lift Up/Lift Down
- Oscillating Axle
- 86 x 150 in. (2.18 x 3.81 m) Platform²
- 4 ft (1.22 m) Manual Deck Extension
- Aluminum Deck with Grip Strips²
- 110V-AC Receptacle in Platform
- 73.5 x 156 in. (1.87 x 3.96 m) All-Steel Platform³
- Adjustable, Removable Platform Control Station
- On-Board Diagnostics at Platform and Ground Control²
- Fuel Gauge in Platform²
- Fold-Down Handrails
- Horn
- Tilt Light and Alarm
- Manual Descent²
- All Motion Alarm

Accessories & Options

- Leveling Jacks¹
- Dual Extension Deck³
- 3,500 Watt Generator²
- Platform Worklights
- 1/2 in. Airline to Platform
- Self-Closing Entry Gates¹
- Flashing Amber Beacon
- 43.5 lb (19.7 kg) Propane Tank
- Cold Weather Start Kit
- 7,500 Watt Generator
- 4,000 Watt Generator³
- Night Bright[®] Package
- PipeRack Accessory

1. Standard on 530LRT
2. Not available on 530LRT
3. Only available on 530LRT

RT SERIES

ROUGH TERRAINS SCISSOR LIFTS



Dimensions

All dimensions are approximate.

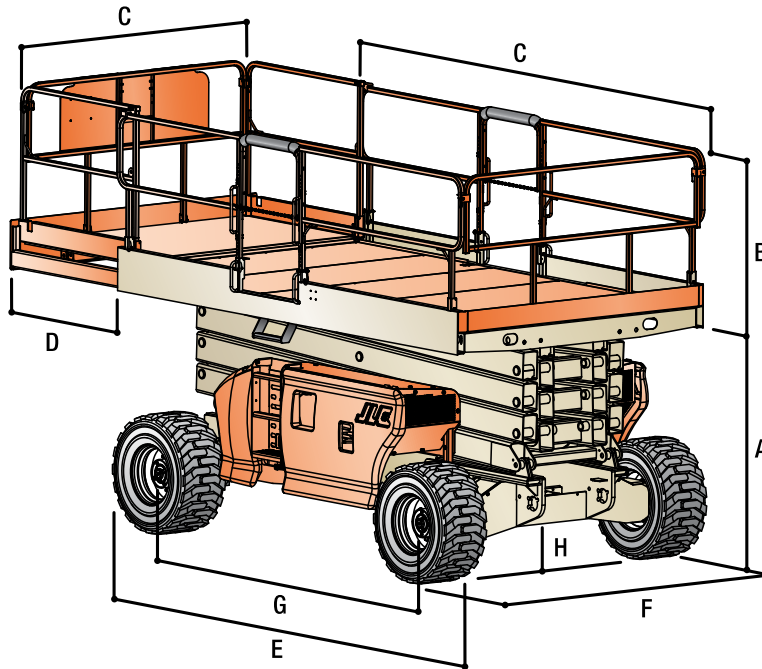

Platform Height — Elevated

3394RT	33 ft	10.06 m
4394RT	43 ft	13.11 m
530LRT	53 ft	16.2 m

A. Platform Height – Lowered

3394RT	5 ft 1.75 in.	1.57 m
4394RT	5 ft 10.4 in.	1.79 m
530LRT	7 ft	2.13 m

B. Platform Railing Height

3394RT/4394RT	3 ft 7.5 in.	1.1 m
530LRT	3 ft 1 in.	0.94 m

C. Platform Size

3394RT/4394RT	86 x 150 in.	2.18 x 3.81 m
530LRT	73.5 x 156 in.	1.87 x 3.96 m

D. Platform Extension

4 ft	1.22 m
------	--------

E. Overall Length

3394RT/4394RT	12 ft 8 in.	3.86 m
530LRT	17 ft	5.18 m

F. Overall Width

3394RT/4394RT	7 ft 10 in.	2.39 m
530LRT	7 ft 7 in.	2.31 m

G. Wheelbase

3394RT/4394RT	9 ft 8 in.	2.95 m
530LRT	9 ft 9 in.	2.97 m

H. Ground Clearance

12 in.	30 cm
--------	-------

The JLG "1 & 5" Warranty

JLG Industries, Inc. backs its products with its exclusive "1 & 5" Warranty. We provide coverage on all products for one (1) full year, and cover all specified major structural components for five (5) years. Due to continuous product improvements, we reserve the right to make specification and/or equipment changes without prior notification. This machine meets or exceeds applicable OSHA Regulations in 29 CFR 1910.67, 29 CFR 1926.453, ANSI A92.5-2006, and CSA Standard CAN3-B354.2-M82, as originally manufactured for intended applications.

Part No.: 3131581
R091507
Printed in USA



JLG Industries, Inc.

1 JLG Drive
McCconnellsburg, PA 17233-9533
Telephone 717-485-5161
Toll-free in US 877-JLG-LIFT
Fax 717-485-6417
www.jlg.com

An Oshkosh Corporation Company